

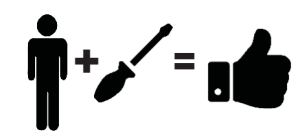

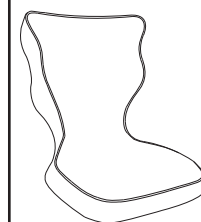







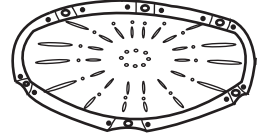



POCKET PLUS

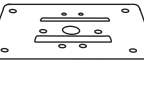
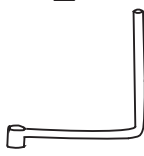

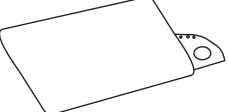
A	B	C	D	E	F		
							
1x	1x	1x	1x	6x	4x M4X15		
G	H	I	J	K	L	M.	N
							
12x M5X15	4x M5X20	2x M5X25	4x M5X35	1x	1x	1x	1x

- F** 
- G** 
- H** 
- I** 
- J** 

 10min.

1

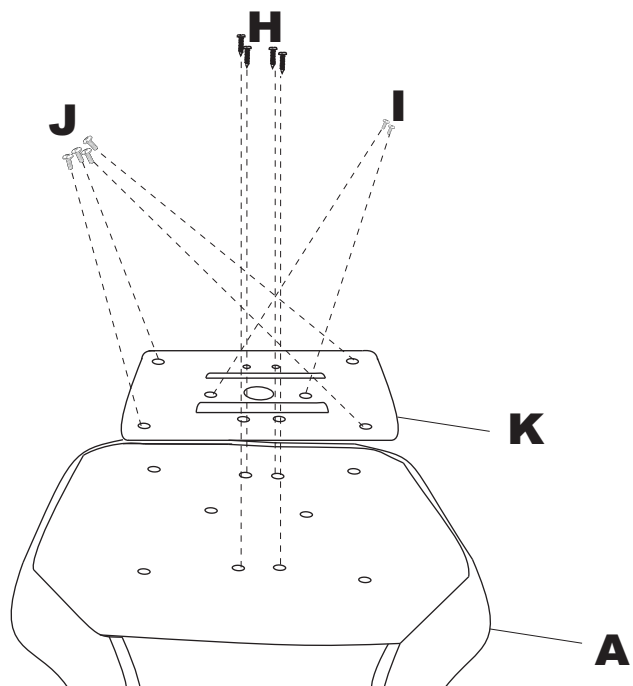

3

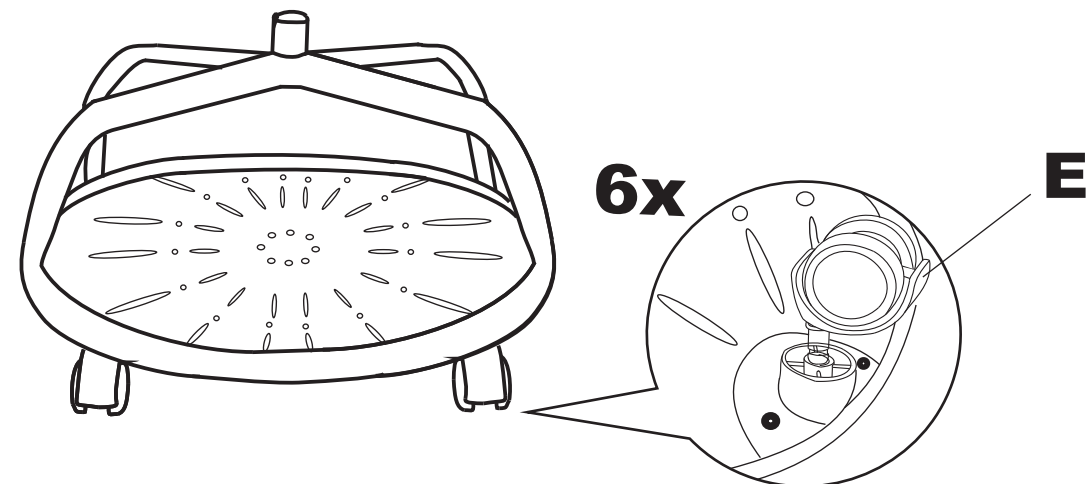

2

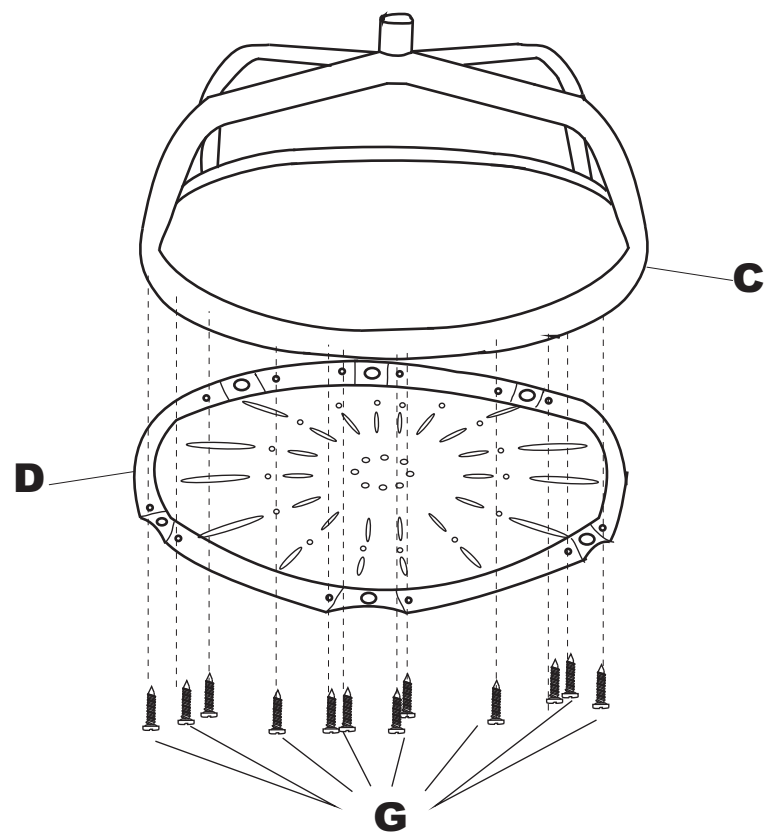

4

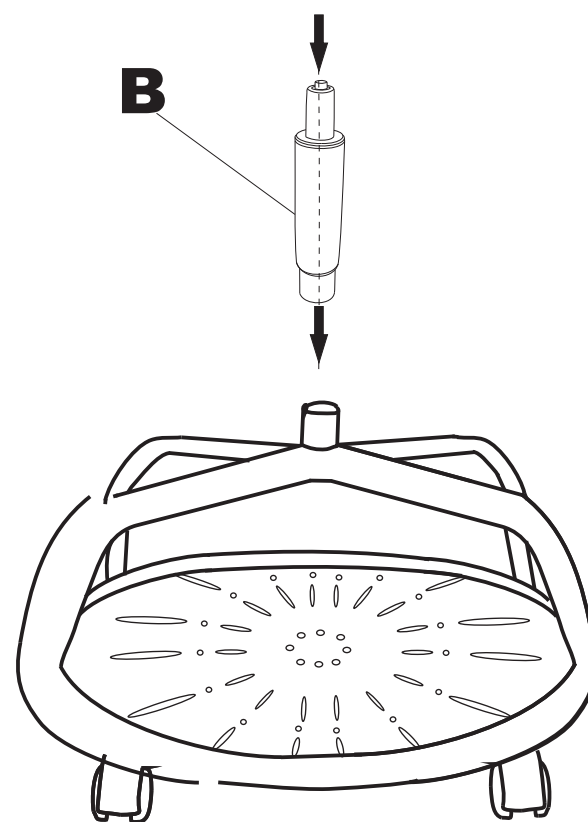

5

